

# ROBAM



## User Manual

Before operating this unit, please read the user manual completely and keep it. If the manual is lost, you can send e-mail to [overseas@robam.com](mailto:overseas@robam.com), request for an electronic manual.

### **CXW-200-A837**

Range Hood

# CONTENTS

Safety Precaution.....	21
Important Information.....	26
Product Description.....	26
Packing List.....	27
Installation.....	28
User Manual.....	35
Maintenance.....	36
Removal of Components.....	36
Circuit Diagram.....	39
Troubleshooting of General faults.....	39

# READ AND SAVE THESE INSTRUCTIONS



**Dear users:**

Thank for your buying our range hood. Please accept our best regards. Please read this user manual carefully before installation and operation.\*The pictures in this manual only for your reference. If the picture isn't accord with object, subject to object. We keep to right to update appearance, structure or products without notice.

## Safety Precaution

In order to avoid harm or property damage to the users or other person, the following distinction and marks are stipulated. They are important safety precaution, please comply strictly based on the full understanding.

**Subject to harmful or destruct degree**







 Danger	If ignore this sign and operate product improperly, it's highly possible to cause danger, serious injury or fire.
 Warning	If ignore this sign and operate product improperly, it's possible to cause danger, serious injury or fire.
 Notice	If ignore this sign and operate product improperly, it's possible to cause injury or loss.

**Notice and Prohibit Mark**

 Prohibit	 Prohibit Flame	 Prohibit Touch	 Prohibit Touch by Wet Hand	 Prohibit Disassembly	 Strict Execution	 Necessary Earthed	 Caution Electric Shock	 Caution Scald
---	--	--	--	--	--	--	--	---

 Warning Please use this product according to manual strictly, or ROBAM shall not take any responsible caused by improper operation.

### Danger

 Prohibit	Don't allow children or weakling to use range hood separately, or it may cause electric shock or other accident.
 Prohibit	Prohibit water on motor, switches or other electric parts; Prohibit wash range hood by water spray. Don't use range hood if wet or it may cause electric leakage or shock.
 Prohibit	Don't change, stretch, bind or press electric wire, or it's possible to cause electric shock or fire because of broken wire.
 Prohibit	Prohibit any change of interior circuit, or it may cause injury or other danger, for example, electric shock or fire.
 Prohibit Touch by Wet Hand	Don't touch plug, electric parts or button by wet hands, or it may cause electric shock.
 Strict Execution	Unplug before cleaning, installing or maintaining, avoiding from electric shock.

### Danger



Please turn off range hood immediately if pan got fire (range hood shall aggravate fire if it's working) and extinguish fire by effective action. For example, cover flame by metal cover, turn off gas valve immediately and remove inflammable things.



Any abnormal, please turn off power, take off plug or cut off electric source, and contact service. It's possible to cause electric shock or fire if using range hood under abnormal situation.

### Warning



Range hood must be installed, disassembled or maintained by professional person.



Stove fire shall be extinguished timely when it is not used; do not flambe under the range hood and it's prohibited to bake food under range hood directly to prevent range hood from damaging and causing accidents.



Do not operate any fan with a damaged cord or plug. Discard fan or return to an authorized service facility examination and/or repair.



Do not run cord under carpeting; Do not cover cord with throw rugs, runners, or similar coverings; Do not route cord under furniture or appliances; Arrange cord away from traffic area and where it will not be tripped over.



Don't touch lamp when it's on or just turned off in a short time, or it may cause scald.



In order to ensure safety, range hood must be installed by specific accessory (especially expansion pipe and wooden screws, or it may cause accidental drop of range hood). The pipe bore and hole must fit tightly during the installation of metal expansion pipe. It is prohibited to make excessively large hole to prevent accidental drop of loosening expansion pipe.











The range hood must be used by specific plug and properly ground it. It's possible to cause electric shock, hot plug or fire because of improper electric wire. Installation must be executed by professional person based on local electrical regulations. Before connect electricity, power must be turned off.









If the supply cord is damaged, it must be replaced by the manufacturer, its service agent or similarly qualified persons in order to avoid a hazard.





 **Warning**

 Strict Execution	All operation must comply with our safety guidelines as well as local safety regulations.
 Strict Execution	There shall be adequate ventilation of the room when the range hood is used at the same time as appliances burning gas or other fuels.
 Strict Execution	For Residential Use Only. And it's not allowed to exhaust dangerous or explosive matter or air. It should be put under dry and ventilation environment without dangerous air.
 Strict Execution	The range hood and electric circuit must be installed by skilled and trained personnel with required qualification. When installation, the related regulation, standard or instruction on fire must be complied. It may cause danger because of improper installation, for example, electric shock, drop or fire accident.
 Strict Execution	The outlet must be connect with outside. In order to ensure safety and fresh air, waste gas should be exhaust to outside. Don't exhaust waste gas to the wall, loft or garage.
 Strict Execution	There is a fire risk if cleaning is not carried out in accordance with the instructions.
 Strict Execution	Keep a good habit to turn off gas hob and gas valve if go outside, sleep or finish operation. Replace or check gas pipe regularly, since gas alarm device can't completely avoid accident caused by gas leakage.
 Strict Execution	<p>TO REDUCE THE RISK OF INJURY TO PERSONS IN THE EVENT OF A RANGE TOP GREASE FIRE, OBSERVE THE FOLLOWING:</p> <p>a) SMOTHER FLAMES with a close-fitting lid, cookie sheet, or metal tray, then turn off the burner. BE CAREFUL TO PREVENT BURNS. If the flames do not go out immediately, EVACUATE AND CALL THE FIRE DEPARTMENT.</p> <p>b) NEVER PICK UP A FLAMING PAN – You may be burned.</p> <p>c) DO NOT USE WATER, including wet dishcloths or towels – a violent steam explosion will result.</p> <p>d) Use an extinguisher ONLY if:</p> <ol style="list-style-type: none"> <li>1) You know you have a Class ABC extinguisher, and you already know how to operate it.</li> <li>2) The fire is small and contained in the area where it started.</li> <li>3) The fire department is being called.</li> <li>4) You can fight the fire with your back to an exit.</li> </ol>









 **Warning**

 Strict Execution	<p><b>TO REDUCE THE RISK OF A RANGE TOP GREASE FIRE:</b></p> <p>a) Never leave surface units unattended at high settings. Boilovers cause smoking and greasy spillovers that may ignite. Heat oils slowly on low or medium settings.</p> <p>b) Always turn hood ON when cooking at high heat or when flambeing food (i.e. Crepes Suzette, Cherries Jubilee, Peppercorn Beef Flambe').</p> <p>c) Clean ventilating fans frequently. Grease should not be allowed to accumulate on fan or filter.</p> <p>d) Use proper pan size. Always use cookware appropriate for the size of the surface element.</p>
 Strict Execution	<p><b>TO REDUCE THE RISK OF FIRE, ELECTRIC SHOCK, OR INJURY TO PERSONS, OBSERVE THE FOLLOWING:</b></p> <p>a) Installation work and electrical wiring must be done by qualified person(s) in accordance with all applicable codes and standards, including fire-rated construction.</p> <p>b) When cutting or drilling into wall or ceiling, do not damage electrical wiring and other hidden utilities.</p> <p>c) Ducted fans must always be vented to the outdoors.</p>
 Strict Execution	<p><b>TO REDUCE THE RISK OF FIRE, USE ONLY METAL DUCTWORK.</b></p>
 Strict Execution	<p><b>TO PROVIDE PROTECTION AGAINST ELECTRIC SHOCK, CONNECT TO PROPERLY GROUNDED OUTLETS ONLY.</b></p>
 Strict Execution	<p><b>GROUNDING INSTRUCTIONS:</b> This appliance must be grounded. In the event of an electrical short circuit, grounding reduces the risk of electric shock by providing an escape wire for the electric current. This appliance is equipped with a cord having a grounding wire with a grounding plug. The plug must be plugged into an outlet that is properly installed and grounded.</p>
 Strict Execution	<p>Improper grounding can result in a risk of electric shock.</p>
 Strict Execution	<p>Consult a qualified electrician if the grounding instructions are not completely understood, or if doubt exists as to whether the appliance is properly grounded.</p>

 **Warning**

 Strict Execution	Do not use an extension cord. If the power supply cord is too short, have a qualified electrician install an outlet near the appliance.
 Strict Execution	This appliance is not intended for use by persons (including children) with reduced physical, sensory or mental capabilities, or lack of experience and knowledge, unless they have been given supervision or instruction concerning use of the appliance by a person responsible for their safety. Children should be supervised to ensure that they do not play with the appliance.

 **Notice**

 Prohibit	The air must not be discharged into a flue that is used for exhausting fumes from appliances burning gas or other fuels, the discharge of air must fulfill the requirements of local regulations.
 Strict Execution	Before removing range hood for installation, clean or maintenance, power must be cut off avoiding from electric shock. When installation, clean or maintenance, protective gloove must be wear avoiding from injury.
 Strict Execution	The temperature for range hood working can't exceed 40°C.
 Strict Execution	Because the installation is difficult and hood is heavy, the installation shall be executed by professional person based on manul.
 Strict Execution	Don't break electric wire or other invisible equipment when cutting something or drilling holes on ceiling.
 Strict Execution	When range hood is using in well sealed building, it should have air inlet or open door to ensure good ventilation.
 Strict Execution	When the oil exceeds 2/3 or near tick mark in the oil cup, clean it in time. Don't eat waste oil from oil cup.
 Strict Execution	The wall of installing range hood needs enough strength. For hollow walls, the thickness of solid layer of hollow wall must be more than 30mm, but for concrete walls, it can be drill holes directly. The range hood must be fixed on the wall firmly.

## ⚠ Notice



**Strict Execution**

Accessible parts may become hot when used with cooking appliances.



**DISPOSAL:** Do not dispose this product as unsorted municipal waste. Collection of such waste separately for special treatment is necessary.

This product must not be disposed together with the domestic waste. This product has to be disposed at an authorized place for recycling of electrical and electronic appliances.

By collecting and recycling waste, you help save natural resources, and make sure the product is disposed in an environmental friendly and healthy way.

## Important Information

### Package of Range Hood

Please settle those packages carefully in order to protect environment.

Don't allow children to play plastic film and package, it may cause asphyxia. Please avoid children near package material.

### Before use Range hood

Please read this manual and all information carefully before installation and operation. Please comply with our suggestion. If it's necessary, please read manual for gas hob. And please keep these manual carefully for future reference.

If range hood has obvious damage, please don't electrify and contact operator.

## Product Description

### Technical Data

Model	CXW-200-A837	Rated Power Input	204W
Power Supply	120V~ 60Hz	Rated Main Motor Power Input	200W
Nominal Wind Pressure	500Pa	Dimension (L×W×H)	(35- <sup>1</sup> / <sub>4</sub> ×20- <sup>9</sup> / <sub>16</sub> ×26- <sup>15</sup> / <sub>16</sub> )" (895×522×684)mm
Max static pressure	800Pa		
Noise	68dB(A)	Net Weight	56.21lbs(25.5kg)

Note: 1. The noise value shown is the A-weighted sound power level;

2. Parameters of noise and others may have deviations of less than 5%.



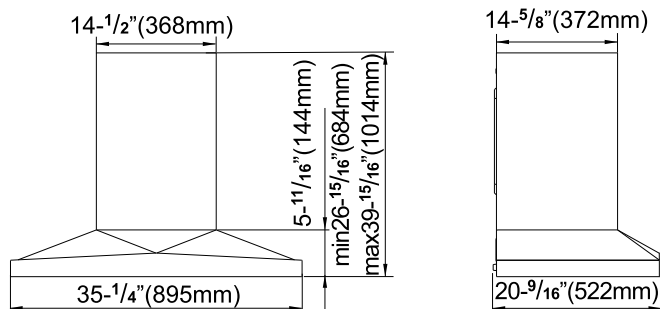







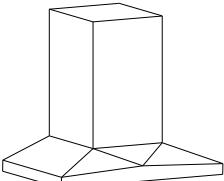



## Size

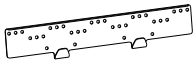

The size marked is for reference only.

## Packing List

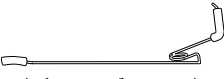
Please check the items in the container upon unpacking

Standard Offerings			
 Range hood	1	 Flexible aluminum duct	1
		 User Manual	1
 Check valve	1	 Plastic expansion pipe	4
 Gasket	1	 4×60 wood screw	4
 Oil cup	1	 ST4.2×18 self tapping screw	10
 Hitching leg	1	 ST4.2×8 self tapping screw	6
 Hitching leg stop block	1	 M6 metal expansion pipe	1
 Host with panel torsion spring	2	 M4×10 countersink screw	2
 Torsion spring bushing	2		

Note: Please mount the oil cup in the container on the mesh enclosure when to use the machine.

## Installation

### Warning

1. The air must not be discharged into a flue that is used for exhausting fumes from appliances burning gas or other fuels, the discharge of air must fulfill the requirements of local regulations.
2. Note that when installing the metal expansion pipe, the pipe shall match with the hole in size. Overlarge hole is prohibited, as it will result in loose pipe and accidental drops.
3. There shall be adequate ventilation of the room when the range hood is used at the same time as appliances burning gas or other fuels.
4. If the flue aperture is less than air duct aperture, it will influence the fume suction effect and the too long air duct will influence the fume suction effect, too.
5. This appliance just for household use only. And it's not allowed to exhaust dangerous or explosive matter or air. It should be put under dry and ventilation environment without dangerous air.

### Preparation for installation

#### ● Surrounding

Keep the hood away from too many doors and windows, so as to avoid air convection affecting the efficiency.

#### ● Tools preparation

The hood will be installed with the following tools

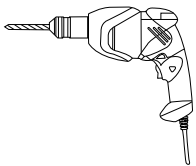

Electric percussion drill



Electric screwdriver

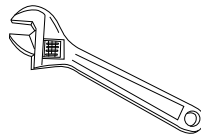

Wrench

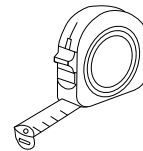

Measuring tape



Gloves

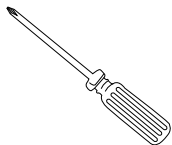

Cross screwdriver

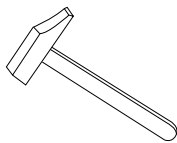

Hammer

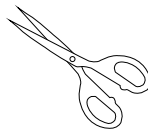

Scissors



Pencil

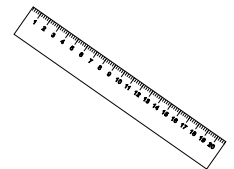

Ruler

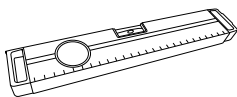

Level meter

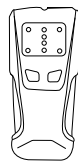

Beam detector



Goggles

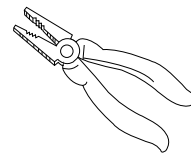

Cutting pliers

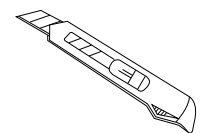

Art knife

## Notice

- Installation and circuit setting must be done by experienced professionals. Only a professionally trained person with an installation qualification can install the hood. Non-professionals are not allowed to install, dismantle and repair the hood.
- Please do not power on the hood before installation to avoid electric shock.
- Do not expose the hood if your kitchen is under renovation, because construction materials, dusts, paint, coatings, and emitted gases will corrode and tarnish the hood surface. Therefore, it is recommended to install it after the renovation is completed.
- If you need move the Gas Hob before installing the Range Hood, please close the main valve before moving the Gas Hob.
- The wall shall be made of noncombustible materials with enough strength and the surface shall be flat.
- The hood may have very sharp edges. So, please wear protective gloves during hood installation, cleaning or repair.
- When drilling on the wall or ceiling board, keep away from embedded wires and other concealed devices to avoid electric shock and fire.
- Do not install the hood at a too high position as well as keep the hood free from disturbance of ambient airflow lest the reduction of smoke pumping effect shall occur.
- When making cabinet, please leave space for installation and disassembly of the hood in order to maintain and overhaul the hood.
- When installing, please keep the machine body remain horizontal.
- Please use single phase grounded socket and the hood shall be well grounded (water pipe grounding is not reliable and gas pipeline grounding has risks of causing fire disaster and explosion).
- In order to ensure safety and successful installation, please use standard accessories provided with the hood for installation, otherwise the hood may be at risk of falling down.
- If the power cord is damaged, in order to avoid danger, it must be replaced by manufacturer, professionals of its maintenance department or similar departments. Please do not carry out restructuring, stretching, knotting and squeezing or apply heavy objects to the power cord, etc., otherwise it may cause power cord damage easily, leading to accidents such as electric shock and fire disaster, etc.
- After installation, please clean the surface of the hood, and then supply power for test run.

## Installation

The range hood should be installed directly above the stove. In order to ensure the safety and the best effect of oil fume suction, it is suggested that the minimum distance between the lowest installation section of the range hood and the cooker supporting surface on the stove should be 25-9/16" (650 mm) and the maximum should not be greater than 29-9/16" (750 mm). If the state or region has laws on installation height of the range hood, it is recommended to comply with the laws, but the fume suction effect of the product may be greatly affected.

The range hood can be installed in two modes: with or without an upper cabinet.

Note: 1. The hitching leg must be fixed to the beam with a screw.

2. Please operate with protective gloves and goggles.

### ● Installation without an upper cabinet

1. Open the container and take out the machine, and check the items inside against the packing list.
2. Draw a vertical center line in the installation position, and then use the beam detector to find the beam to fix the hitching leg, and mark it with a pencil; At the same time, open air duct holes in the ceiling according to the dimensions shown in the figure below.

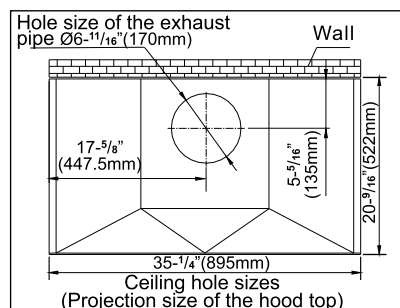
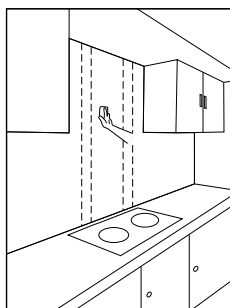
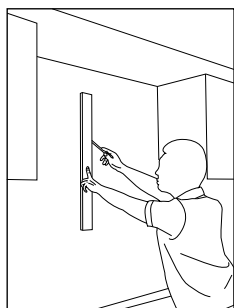
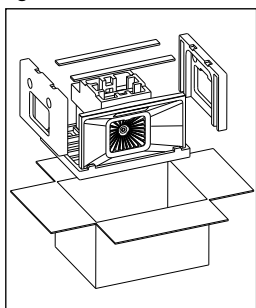

3. Determine the positions to fix the hitching leg and the hitching leg stop block.

Note: The hitching leg must be fixed on the beam with a screw. With the stove bearing surface as the base, mark the drill holes in the corresponding position of the wall according to the distance from the hitching leg hole to the bottom of the machine, and the height of the bottom of the hanging cabinet. The relevant size is given as below:

1). Range hood: the distance from the bottom of the machine (the bottom of the cabinet) to the stove bearing surface is  $25\frac{9}{16}$ - $29\frac{9}{16}$ "(650-750mm);

2). Hitching leg: the distance from the center of the hitching leg to the bottom of the machine is  $24\frac{13}{16}$ "(630mm).

4. Drill a hole  $2\frac{3}{8}$ - $2\frac{3}{4}$ "(60-70mm) deep (not too large) at the mark with a drill bit with a diameter of  $\frac{5}{16}$ "(8mm), press the expansion pipe into the hole, use the 4×60mm wood screws provided with the machine to securely fix the hanging feet. Drill a hole with a diameter of  $\frac{3}{8}$ "(10mm)(not too large) and a depth of  $2\text{-}2\frac{3}{16}$ "(50-55mm) at the fixing hole mark of the hitching leg stop block, and insert the M6 metal expansion pipe into the hole.

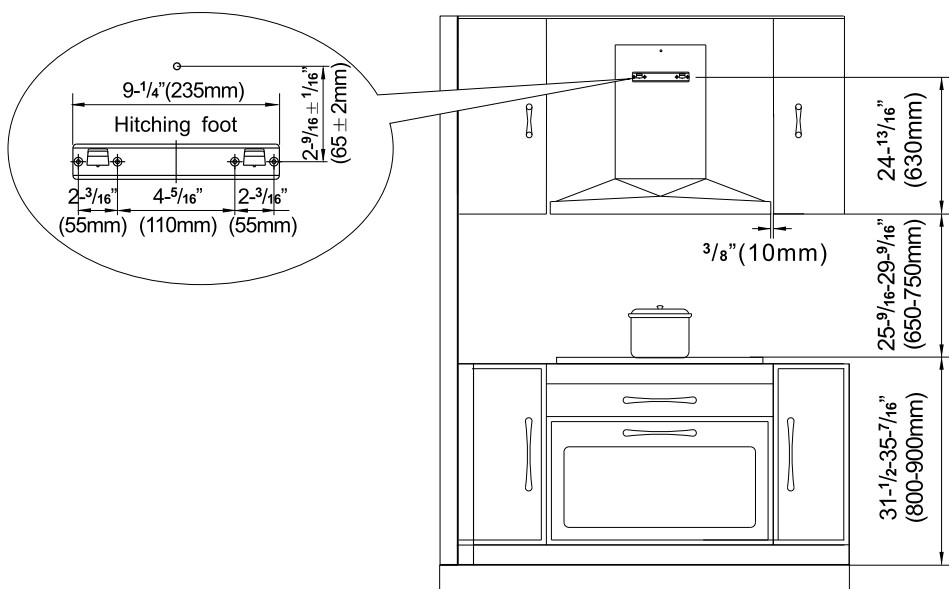

5. Pull the two supports of the attached panel of the mainframe with both hands and pull them upward, tear off the protective film of the panel and the attached panel of the mainframe, and insert the attached panel of the mainframe back along the gap between the panel of the mainframe and the shell.

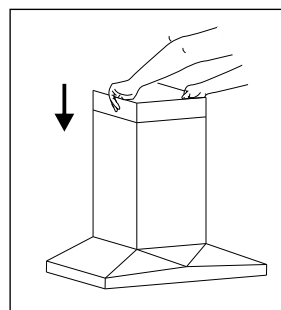
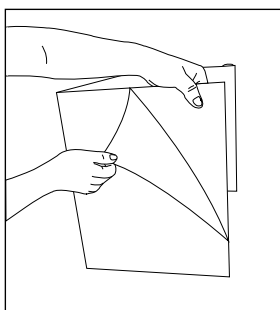
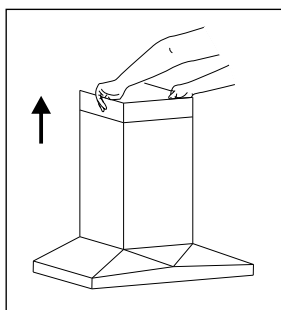



6. The installation of the drawing panel torsional spring on the attached panel of the main engine mainly includes the following steps :

- 1). Firstly, put torsional spring rubber sleeve on drawing panel torsional spring, then put torsional spring case on drawing panel torsional spring.
- 2). Firstly put drawing panel torsional spring into nut-insert, then put torsional spring into nut-insert, finally, fix torsional spring lining and nut-insert with M4×10 screw.
- 3). Push drawing panel torsional spring on both ends of drawing panel from dotted line position to solid line position as shown in figure to fixed them.

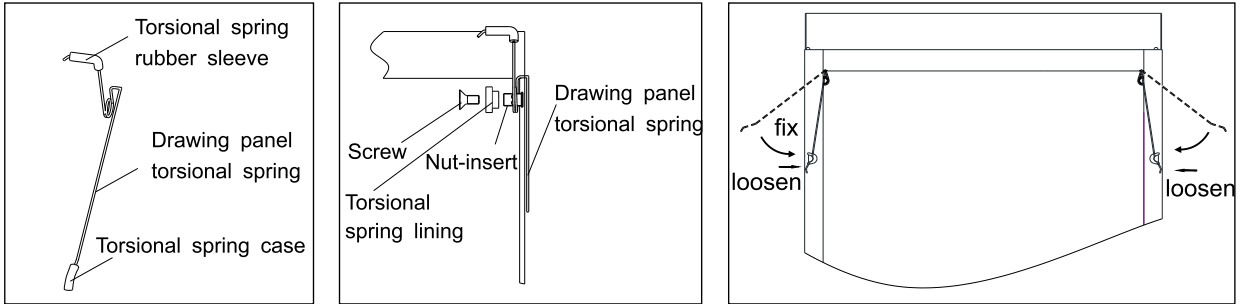

7. Fix the check valve on the range hood as shown in the figure, then lift the range hood and hang the back hook hole up at the hitching leg on the wall at an angle, shake it with your hands to see if the body is fastened.

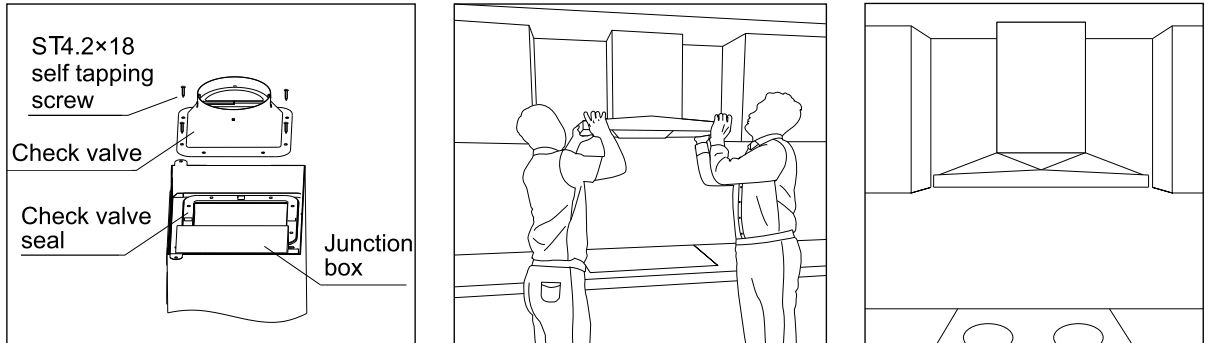

8. After the machine is installed in place, install the hitching leg stop block and the gasket on the M6 metal expansion pipe, and tighten the nut (to prevent the machine from decoupling accidentally under external force).

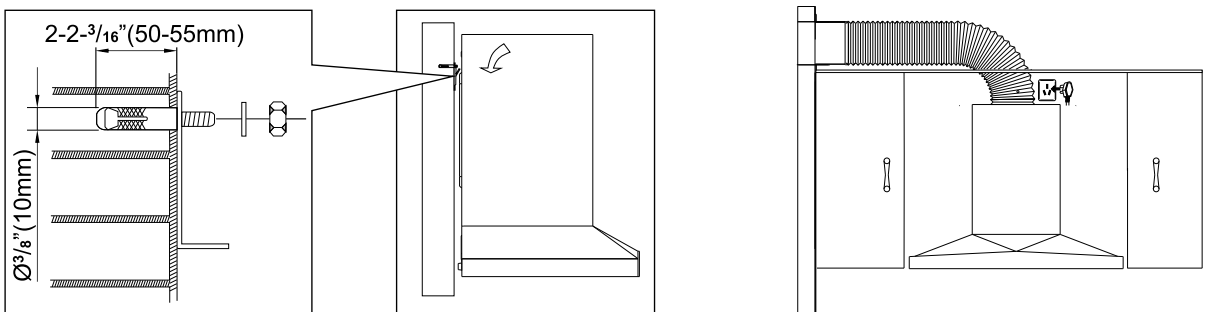

9. Attach the duct to the check valve and seal with aluminum tape, and then plug it in.

Note: Please straighten the flexible aluminum duct when mounting, to avoid noise generated when the flexible aluminum duct is semi-stretched, and cut off the excess parts with wire pliers. The connection between the air outlet pipe and the wall hole or the public flue must be tightly sealed to ensure that the air outlet pipe is firmly connected with the check valve or the public flue, and ensure that the blade at the connection of the check valve or the public flue is opened and closed flexibly.

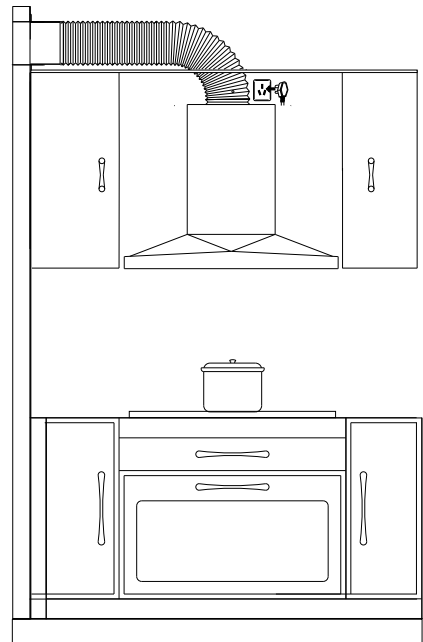

10. At this time, there is still a certain gap between the attached panel of the mainframe and the roof, so the attached panel of the mainframe should be pulled out and pushed to contact with the roof, and then the attached panel of the mainframe should be fixed on the roof with ST4.2×18 screws.

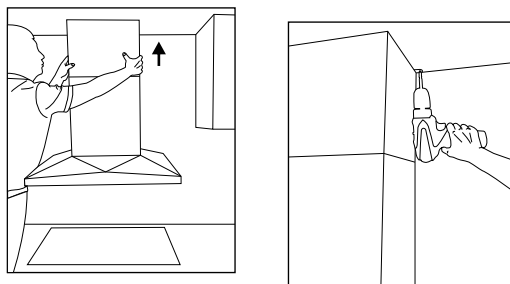

11. After installation, the whole machine must be kept horizontal. In the end, insert the oil cup into the hitching leg on the bottom of the mesh enclosure and power it for trial operation.

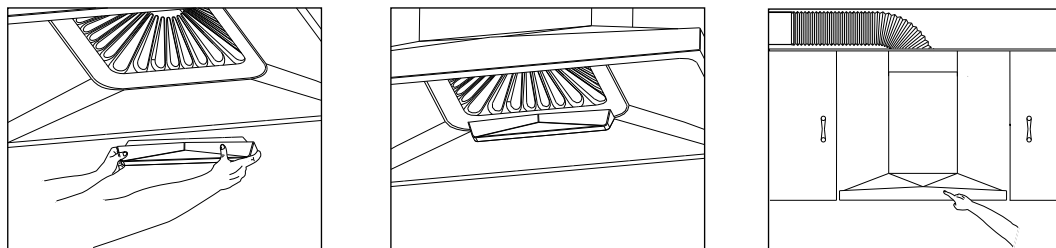

### ● Installation with an upper cabinet

1. Open the container and take out the machine, and check the items inside against the packing list.
2. Draw a vertical center line in the installation position, and then use the beam detector to find the beam to fix the hitching leg, and mark it with a pencil; At the same time, open air duct holes in the ceiling according to the dimensions shown in the figure below.

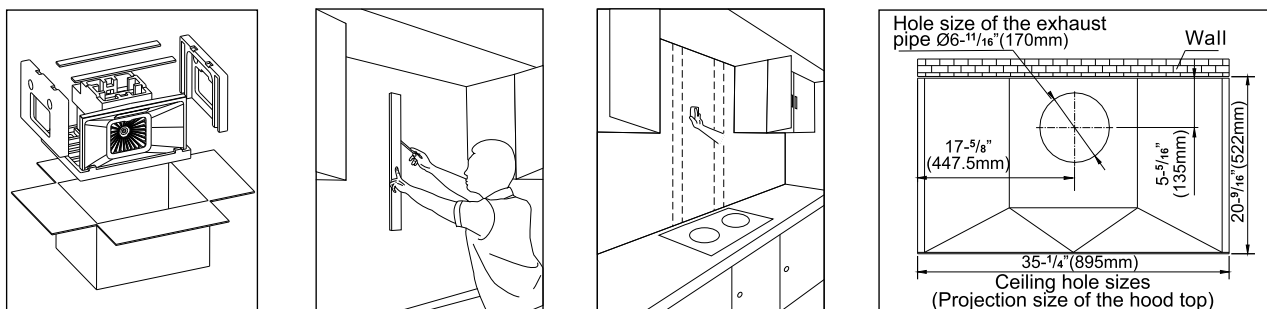

3. Determine the positions to fix the hitching leg and the hitching leg stop block.

Note: The hitching leg must be fixed on the beam with a screw.

With the stove bearing surface as the base, mark the drill holes in the corresponding position of the wall according to the distance from the hitching leg hole to the bottom of the machine, and the height of the bottom of the hanging cabinet. The relevant size is given as below:

- 1). Range hood: the distance from the bottom of the machine (the bottom of the cabinet) to the stove bearing surface is  $25\text{-}\frac{9}{16}\text{-}29\text{-}\frac{9}{16}\text{'}$  (650-750mm);
- 2). Hitching leg: the distance from the top of the hitching leg to the bottom of the machine is  $24\text{-}\frac{13}{16}\text{'}$  (630mm).

4. Drill a hole  $2\frac{3}{8}$ - $2\frac{3}{4}$ " (60-70mm) deep (not too large) at the mark with a drill bit with a diameter of  $\frac{5}{16}$ " (8mm), press the expansion pipe into the hole, use the 4×60mm wood screws provided with the machine to securely fix the hanging feet. Drill a hole with a diameter of  $\frac{3}{8}$ " (10mm) (not too large) and a depth of  $2\text{-}2\frac{3}{16}$ " (50-55mm) at the fixing hole mark of the hitching leg stop block, and insert the M6 metal expansion pipe into the hole.

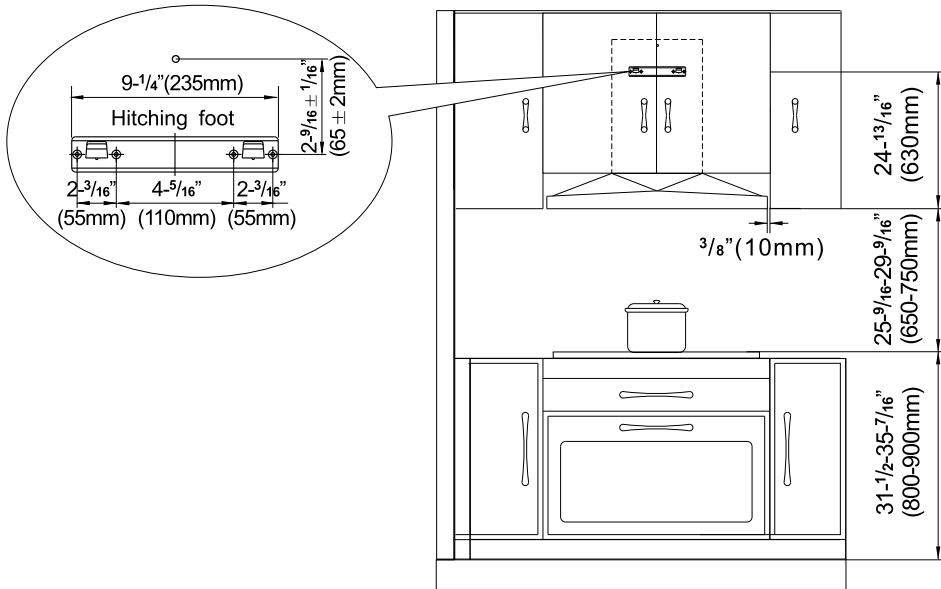

5. Make holes on the cabinet floor according to the size shown in the illustration.

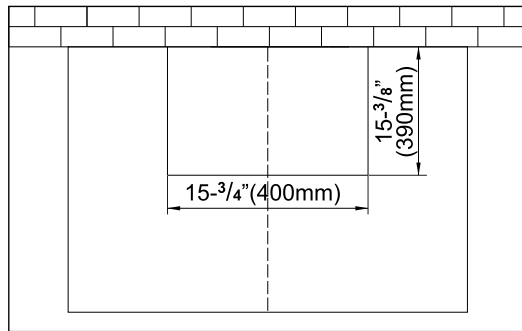

6. Pull the two supports of the attached panel of the mainframe with both hands and pull them upward, tear off the protective film of the panel and the attached panel of the mainframe, and insert the attached panel of the mainframe back along the gap between the panel of the mainframe and the shell.

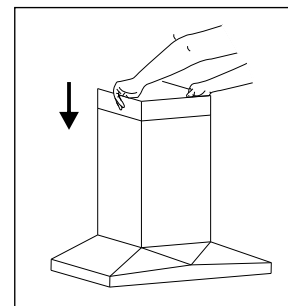
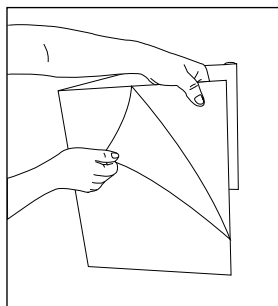
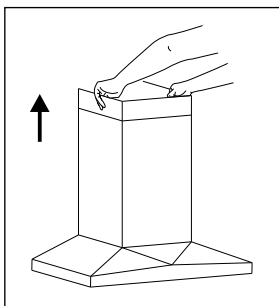

7. The installation of the drawing panel torsional spring on the attached panel of the main engine mainly includes the following steps :

- 1). Firstly, put torsional spring rubber sleeve on drawing panel torsional spring, then put torsional spring case on drawing panel torsional spring.
- 2). a. Firstly put drawing panel torsional spring into nut-insert, then put torsional spring into nut-insert, finally, fix torsional spring lining and nut-insert with M4×10 screw.
- 3). Push drawing panel torsional spring on both ends of drawing panel from dotted line position to solid line position as shown in figure to fixed them.

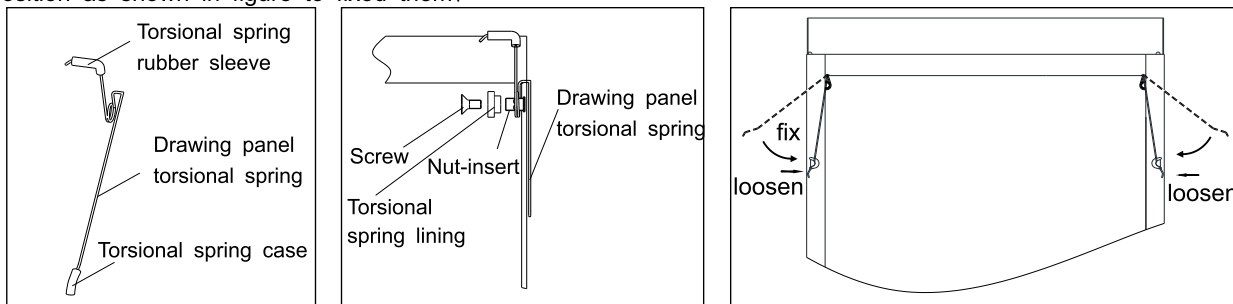

8. Fix the check valve on the range hood as shown in the figure, then lift the range hood and hang the back hook hole up at the hitching leg on the wall at an angle, shake it with your hands to see if the body is fastened.

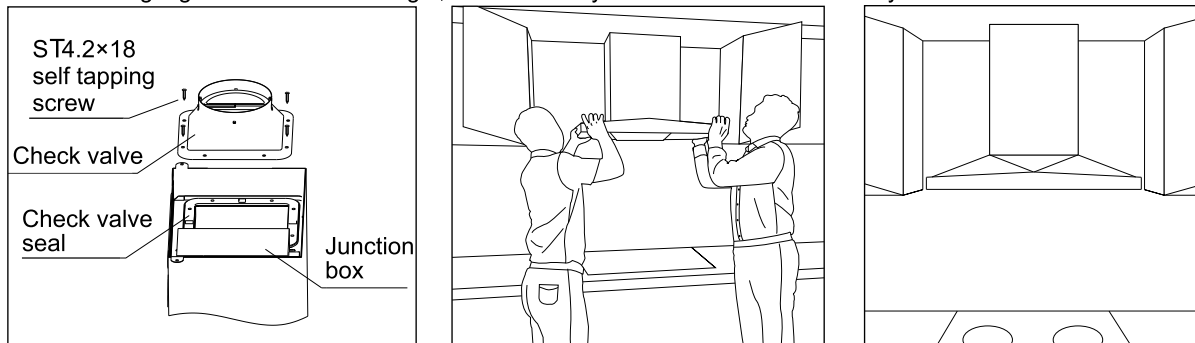

9. After the machine is installed in place, install the hitching leg stop block and the gasket on the M6 metal expansion pipe, and tighten the nut (to prevent the machine from decoupling accidentally under external force).

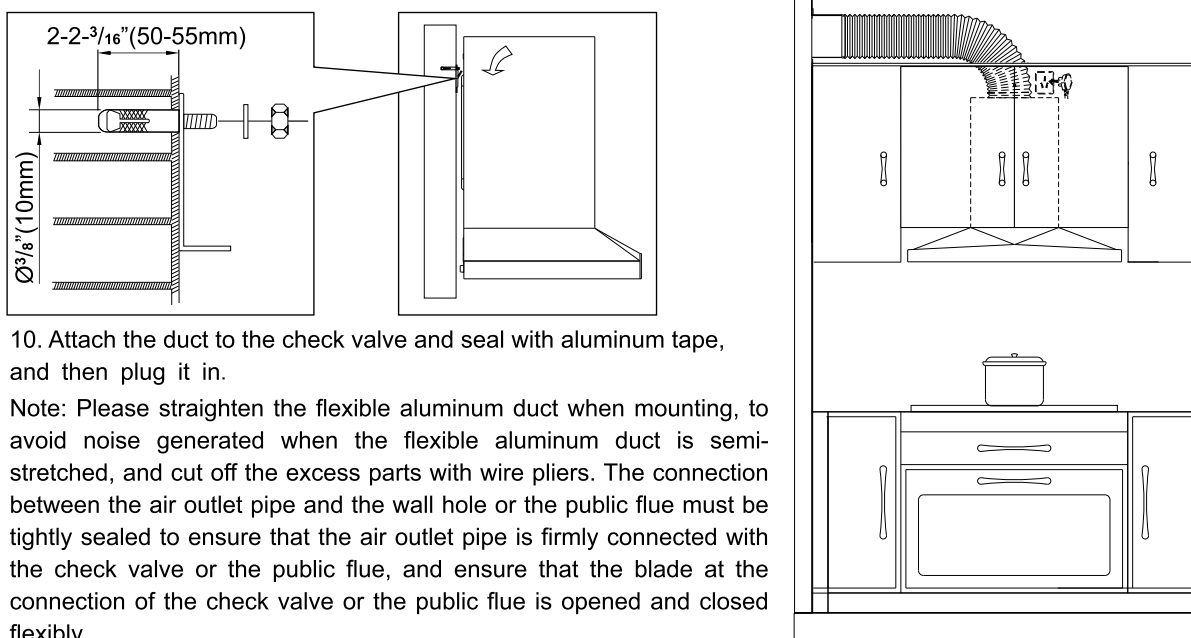

10. Attach the duct to the check valve and seal with aluminum tape, and then plug it in.

Note: Please straighten the flexible aluminum duct when mounting, to avoid noise generated when the flexible aluminum duct is semi-stretched, and cut off the excess parts with wire pliers. The connection between the air outlet pipe and the wall hole or the public flue must be tightly sealed to ensure that the air outlet pipe is firmly connected with the check valve or the public flue, and ensure that the blade at the connection of the check valve or the public flue is opened and closed flexibly.



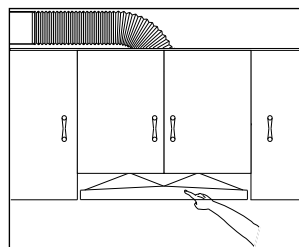
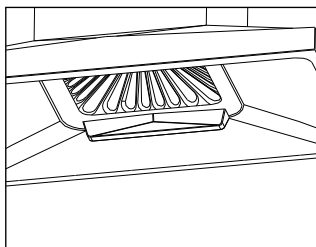
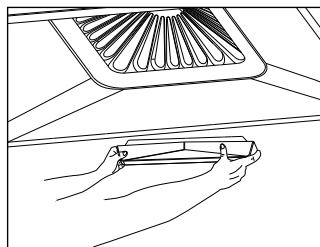

11. After installation, the whole machine must be kept horizontal. In the end, insert the oil cup into the hitching leg on the bottom of the mesh enclosure and power it for trial operation.

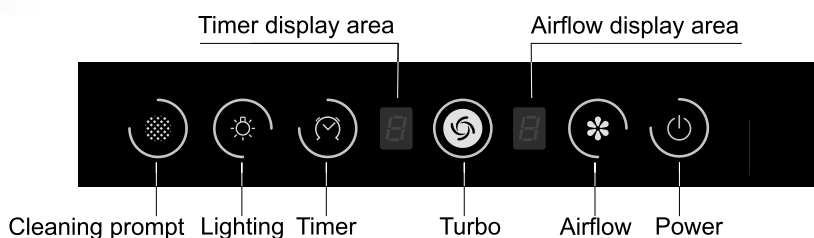

## User Manual

### Switch Control Panel



 <p>Power</p>	<p>When the power button icon is on, if only the light is on, press “Power” button to turn off the light directly; if the fan is working when the power is on, press the “Power” button to make the power button icon flash and the range hood enter the delay status, then turn off the fan 1 minute later; if the power button icon is flashing, press the “Airflow” or “Turbo” button to cancel the delay, press the “Power” button to turn off all functions.</p>
 <p>Airflow</p>	<p>When the power button icon is on, press the “Airflow” button, the airflow display area displays “3”; press the “Airflow” button again, the airflow display area displays “2”. Each time the icon is pressed, the airflow will be decreased by one gear.</p>
 <p>Turbo      Airflow</p>	<p>When the power button icon is on, press the “Turbo” button, the range hood will adjust the airflow automatically according to the external pressure. The airflow display area displays one of “4th”, “5th” and “6th” gear correspondingly. The use can also enter turbo time function setting by extended pressing the “Turbo” button, and adjust the time by pressing the “Turbo” button briefly. The timer display area shows the tens place, while the airflow display area shows the ones place at an increment of 1 minute, with a maximum of 15 minutes long and a minimum of 2 minutes. Upon completion of time setting, it will be automatically determined 3 seconds later in case of no button operation.</p>
 <p>Timer</p>	<p>At the power-on state, press the “Timer” button once, the timer display area displays “1”, indicating that the timing is 10 minutes. The range hood will give the tone to remind the user the time set is up. If the button is pressed twice, the timer display area displays “2”, indicating that the timing is 20 minutes by that analogy. A maximum of 60 minutes is allowed. After the time set is up, press any key to cancel the tone.</p>
 <p>Lighting</p>	<p>Press the “Lighting” button, the light is on, then press the “Lighting” button again to turn off the light. The “Lighting” button only controls the light.</p>



Cleaning prompt

The machine has a cleaning reminder function. When the range hood has operated for 60 hours, the cleaning prompt icon will be on for a long time, and the buzzer will sound to remind the user of oil net cleaning. At this time, the user may cancel the prompt by extended pressing the button; otherwise, the cleaning prompt icon will be on for 1 hour and then extinguish automatically. The user can also query the elapsed time of motor operation by extended pressing the "Turbo" button in off state. The timer display area displays the tens place, while the airflow display area displays the ones place, at an increment of 1 hour, with a maximum of 60 hours. The display extinguishes 5 seconds later.

## Maintenance

### Warning

1. There is a fire risk if cleaning is not carried out in accordance with the instructions.
2. Cleaning and maintenance shall be conducted under outage. Electrical components such as motor, switch, and connector shall not be spoiled by water so as to prevent from accidents.
3. It's prohibited to wash with water so as to prevent accidents.
4. Stove fire shall be extinguished timely when it is not used; do not flambe under the range hood and it's prohibited to bake food under range hood directly to prevent range hood from damaging and causing accidents.
5. If the supply cord is damaged, it must be replaced by the manufacturer, its service agent or similarly qualified persons in order to avoid a hazard.

### Considerations

● The hood shall be cleaned and maintained regularly depending on the surroundings, so as to keep its cleanness & efficiency and extend its service life.

We recommend that: Clean the outer surface of range hood after each cooking.

● It is recommended to use a neutral detergent to clean instead of strong detergents, and dry with a soft cloth. If your range hood is a mechanical switch, and should avoid the cleaning agent from contacting each control button.

● Do not allow stains to stay on the surface of the hood for too long.

● Please do not use cleaning balls, brushes and other rough objects to clean the hood to prevent the body surface from scratching.

● When cleaning or maintaining the hood, please wear protective gloves to prevent wounding during wiping.

● Please regularly check and clean the oil cup. Please check regularly and clean the oil cup, hold the oil cup with both hands when the oil in the oil cup is about to reach the tick mark. Shift out and remove the waste oil.

● The range hood shall be started before cooking.

● Please unplug it during long-term shutdown, but please do not pull hard.



## Removal of Components

### Warning

1. As a general rule, the hood body does not need to remove, and removal shall be done by professional maintainers. Nonprofessionals are forbidden to remove, install and repair the hood.
2. Before cleaning, installation or maintenance for the range hood, cut off the power supply to avoid electric shock.

Note: The installation procedures of the following components are in reverse with the removal. Please wear protective gloves during operation to prevent the sharp edge of metal hurting your hands.

## Lamp removal

1. Unplug the power plug;
2. Embed a small flathead screwdriver or something sharp and small in the installation gap between lamp shade and vessel hood, and force outward to take out the spotlight from the vessel hood;
3. Pull out the lamp connector terminal and replace the spotlight;

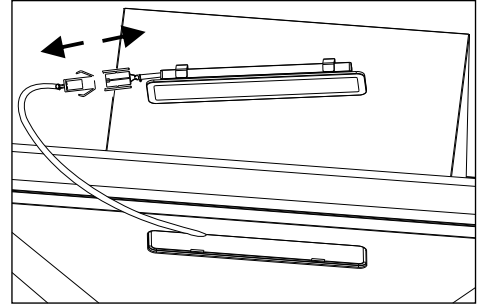
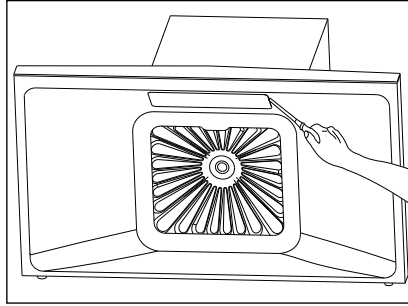
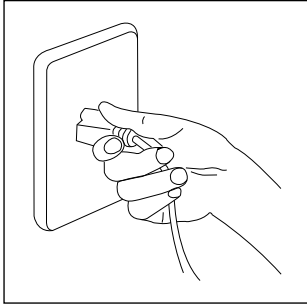

Lamp image		Lamp information	
		Lamp Type	Rectangular LED
		Max Power	4W
		Voltage	12VDC
		Dimension	see the lamp image

## Switch removal

1. Take down the oil cup with both hands at first;
2. Insert a small flathead screwdriver or something sharp in the gap between the light cover and hood, raise it outward forcibly to remove the spotlight from the hood Pull out the connector to replace the spotlight;
3. After removing the light, use a Phillips screwdriver to remove the two screws on the switch. Push the switch assembly diagonally upward to take it out from the lamp hole for repair and replacement.

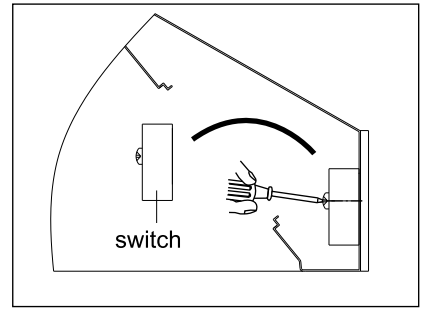
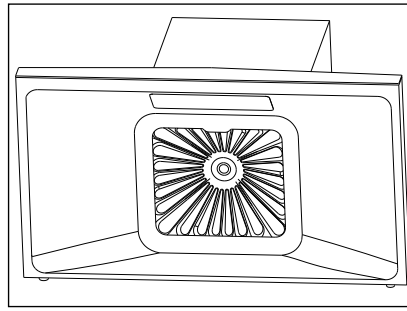
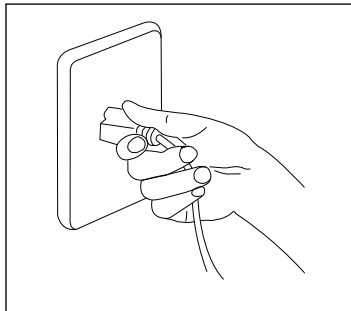

## Mesh Enclosure Removal

1. Take down the oil cup with both hands at first;
2. Aim the cross screwdriver at the screw hole and rotate counterclockwise about 90 degrees while slightly forcing up the screwdriver, to remove one screw from the catch slot on one side of the hood. Then support the bottom of the mesh enclosure with one hand, and unscrew the other side with the screwdriver with the other hand;
3. Hold the two ends of the mesh enclosure with both hands, and pull in the direction as indicated by the arrow to take it out.

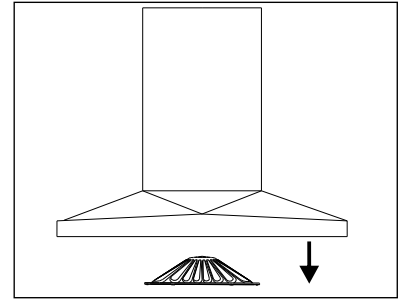
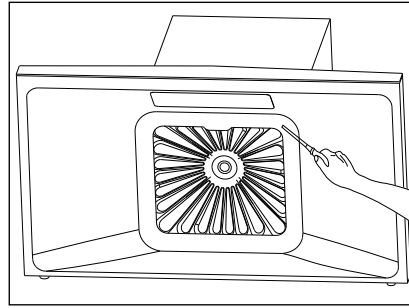
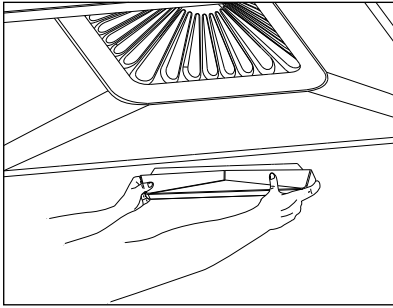

## Removal Steps of Body

1. Pull out the plug;
  2. Take down the oil cup;
  3. Loosen drawing panel torsional spring in accordance, then insert drawing panel into decorative panel;
  4. Unscrew the four screws from the back of the decorative panel. Remove the decorative panel and drawing panel.
  5. Remove the noise absorption sponge from both side;
  6. Use a Phillips screwdriver to unscrew 4 screws from the top and both side of acoustic baffle, then remove the acoustic baffle.
  7. Unscrew the fastening screws on the retaining ring to remove the retaining ring;
  8. Unscrew the cap clockwise and take out the impeller vertically;
  9. Take down the filter mesh according to the instruction steps of "Filter mesh removal";
- The installation and removal procedure in reverse. (When mounting the impeller, apply some lubricant to the shaft hole.)

Note: Step 3 is unnecessary if no drawing panel is installed.

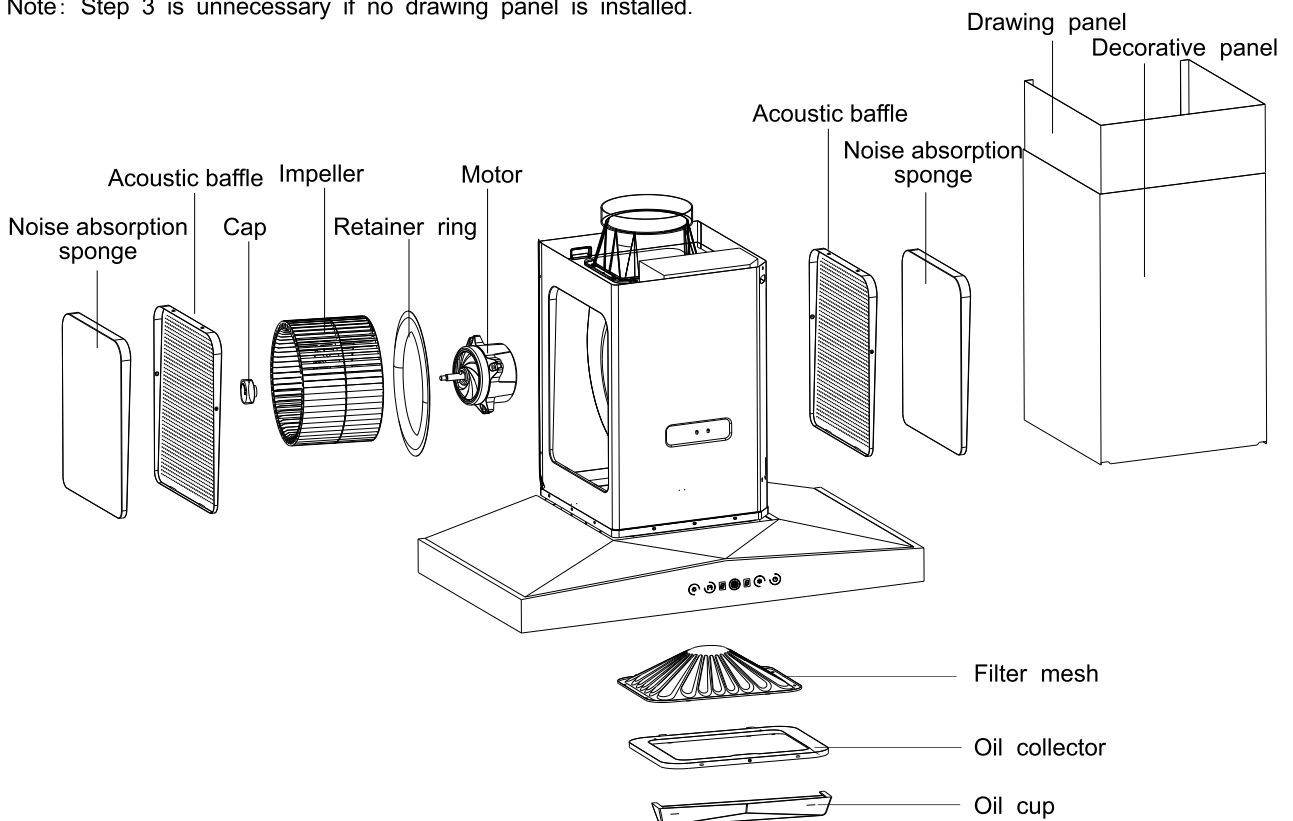



## Circuit Diagram

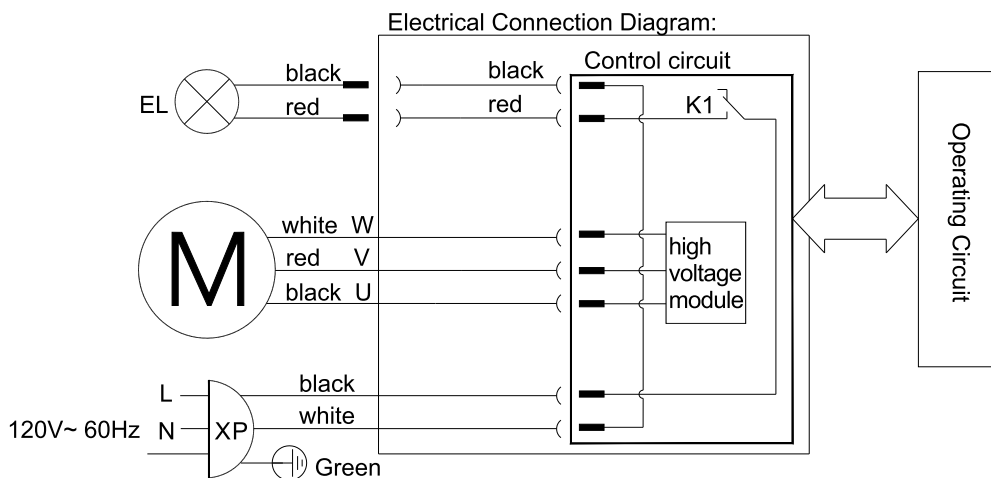

## Troubleshooting of General faults

Serial number	Fault	Cause	Solution
1	No response after pressing any icon (e. g. the impeller does not rotate, or the light is off)	The power plug is not connected properly or there is power failure	Plug in the power plug
2	Pressing the lighting icon, the headlamp is not lit	The light is damaged or poorly connected	Replace the light or plug in the plug
3	Induced current exists on the hood body may paralyze hands	The power socket is not grounded well	Use single-phase three-pole socket and well grounded
4	Abnormal sound during impeller running	The impeller is loose, and the cap is not tightened	Tighten the cap
5	No oil in the oil cup after a period of time	The hood body is tilt	Adjust the body to the horizontal state
 Warning	1. When connecting or replacing the plug, please unplug the power plug. 2. If the range hood's power cords are damaged, it must be replaced by our company's professional maintenance staff.		